

Content

1 x Mounting kit

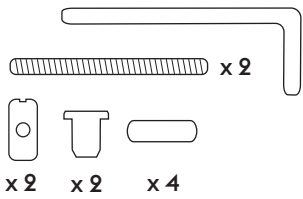

2 x Side pieces

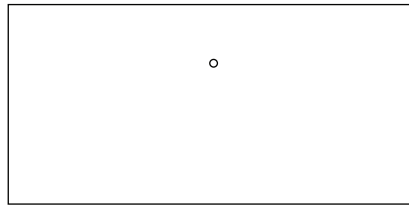

5-6 x Flat brackets
(depending on model)



1 x Bridge piece

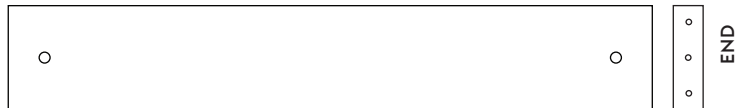

3 x Screws per bracket

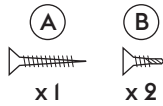

IMPORTANT!

We recommend two people for the assembly as the furniture will be turned upside down. The same applies if the furniture is to be moved – get help from a friend to lift the furniture instead of pulling/pushing it.

1.

Fit the bridge piece between the two side pieces using the mounting kit provided.

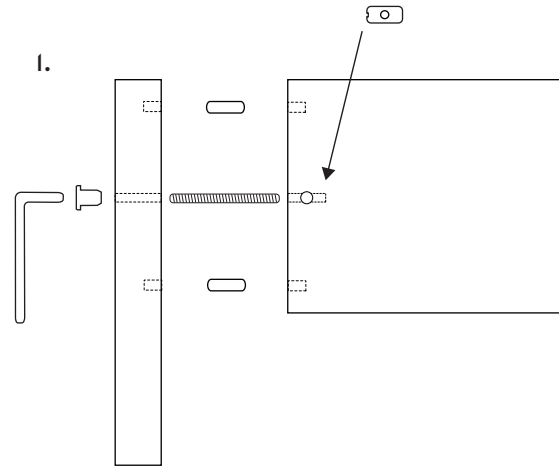

2.

Fasten all flat brackets with the supplied screws (A) into the recesses on the leg stand.

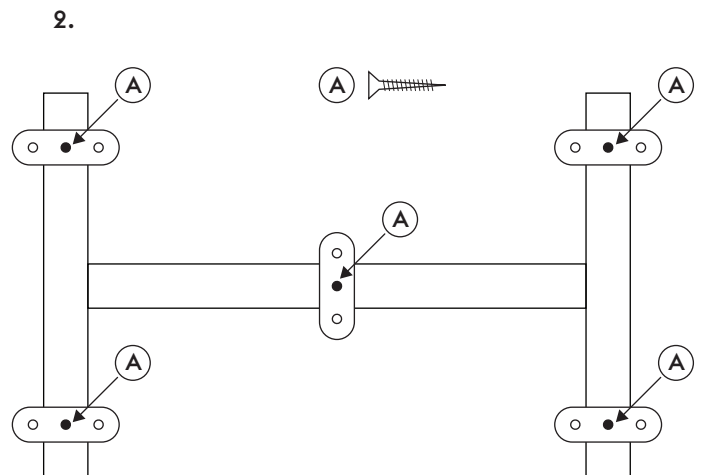

3.

Place your furniture upside down on a flat surface covered with protective material to avoid scratches.

Security!

Be sure to always follow the safety instructions that apply to your furniture. Always secure the cabinet to the wall. This also applies to low cabinets where the weight distribution changes drastically when the fronts open. Especially in the case of solid quality fronts as ours. Use the anchor brackets supplied with the Ikea cabinet.

4.

Place your Takumi leg upside down on the bottom of the furniture and secure all the flat brackets in place with the supplied screws (B).

5.

With the help of a friend, lift the furniture to turn it back over. Then put it straight down in its place and behold the result!

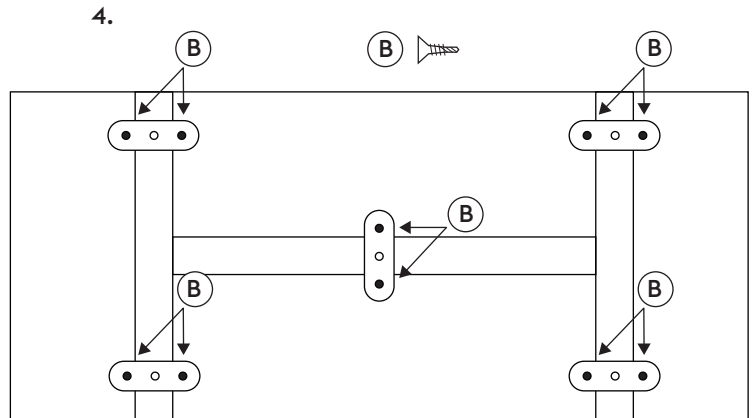

The result varies depending on the width of the furniture/leg.

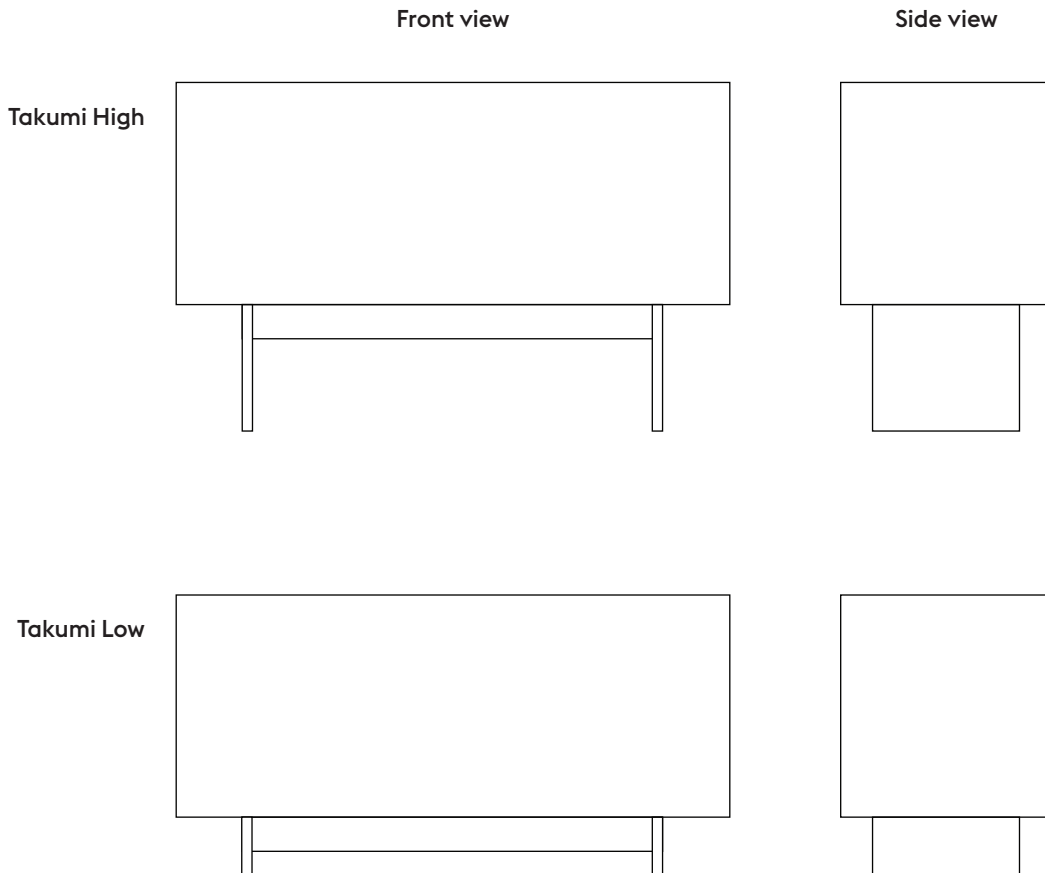

Security!

Be sure to always follow the safety instructions that apply to your furniture. Always secure the cabinet to the wall. This also applies to low cabinets where the weight distribution changes drastically when the fronts open. Especially in the case of solid quality fronts as ours. Use the anchor brackets supplied with the Ikea cabinet.